

Number of contacts

6/36+

690 V / 160 V
40 A/10 A

Han-Com

Identification

Wire cross section (mm²)

Part number
male female

Drawing
Dimensions in mm

Han-Com®,
Crimp/crimp terminal



Please order crimp contacts separately.

09 38 042 3001

09 38 042 3101

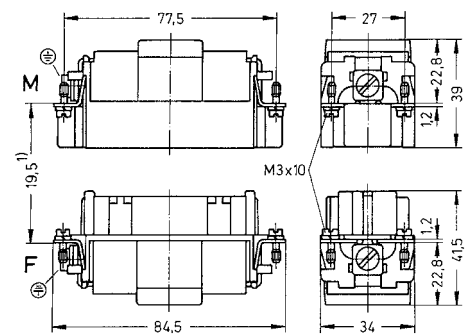

1) Distance for contact max. 21 mm
Max. insulation diameter 5 mm

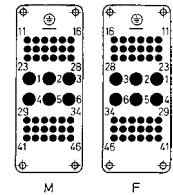

Contact arrangement (view from termination side)

Han D®,
Crimp contact,
gold plated contacts,
contact resistance ≤3 mOhm



0.14–0.37
0.5
0.75
1
1.5
2.5

09 15 000 6124
09 15 000 6123
09 15 000 6125
09 15 000 6122
09 15 000 6121
09 15 000 6126

09 15 000 6224
09 15 000 6223
09 15 000 6225
09 15 000 6222
09 15 000 6221
09 15 000 6226

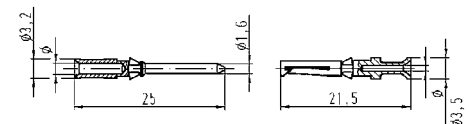

Wire gauge	∅	Stripping length
0.14-0.37 mm ² AWG 26-22	0.9 mm	8 mm
0.5 mm ² AWG 20	1.1 mm	8 mm
0.75 mm ² AWG 18	1.3 mm	8 mm
1 mm ² AWG 18	1.45 mm	8 mm
1.5 mm ² AWG 16	1.75 mm	8 mm
2.5 mm ² AWG 14	2.25 mm	6 mm

Han D®,
Crimp contact,
silver plated contacts,
contact resistance ≤3 mOhm





0.14–0.37
0.5
0.75
1
1.5
2.5

09 15 000 6104
09 15 000 6103
09 15 000 6105
09 15 000 6102
09 15 000 6101
09 15 000 6106

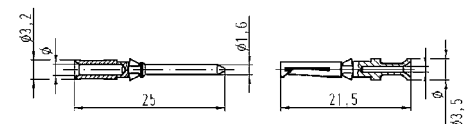
09 15 000 6204
09 15 000 6203
09 15 000 6205
09 15 000 6202
09 15 000 6201
09 15 000 6206

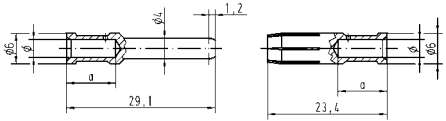

Wire gauge	∅	Stripping length
0.14-0.37 mm ² AWG 26-22	0.9 mm	8 mm
0.5 mm ² AWG 20	1.1 mm	8 mm
0.75 mm ² AWG 18	1.3 mm	8 mm
1 mm ² AWG 18	1.45 mm	8 mm
1.5 mm ² AWG 16	1.75 mm	8 mm
2.5 mm ² AWG 14	2.25 mm	6 mm

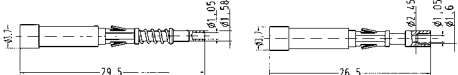
Identification	Wire cross section (mm ²)	Part number		Drawing Dimensions in mm																		
		male	female																			
Han® C, Crimp contact, silver plated contacts, contact resistance ≤1 mOhm 	1.5	09 32 000 6104	09 32 000 6204	 <table border="1" data-bbox="1038 501 1497 636"> <thead> <tr> <th>Wire gauge</th> <th>∅</th> <th>Stripping length</th> </tr> </thead> <tbody> <tr> <td>1.5 mm² AWG 16</td> <td>1.75</td> <td>9.5 mm</td> </tr> <tr> <td>2.5 mm² AWG 14</td> <td>2.25</td> <td>9.5 mm</td> </tr> <tr> <td>4 mm² AWG 12</td> <td>2.85</td> <td>9.5 mm</td> </tr> <tr> <td>6 mm² AWG 10</td> <td>3.5</td> <td>9.5 mm</td> </tr> <tr> <td>10 mm² AWG 8</td> <td>4.3</td> <td>12 mm</td> </tr> </tbody> </table>	Wire gauge	∅	Stripping length	1.5 mm ² AWG 16	1.75	9.5 mm	2.5 mm ² AWG 14	2.25	9.5 mm	4 mm ² AWG 12	2.85	9.5 mm	6 mm ² AWG 10	3.5	9.5 mm	10 mm ² AWG 8	4.3	12 mm
	Wire gauge	∅	Stripping length																			
	1.5 mm ² AWG 16	1.75	9.5 mm																			
	2.5 mm ² AWG 14	2.25	9.5 mm																			
4 mm ² AWG 12	2.85	9.5 mm																				
6 mm ² AWG 10	3.5	9.5 mm																				
10 mm ² AWG 8	4.3	12 mm																				
2.5	09 32 000 6105	09 32 000 6205																				
4	09 32 000 6107	09 32 000 6207																				
6	09 32 000 6108	09 32 000 6208																				
F.O. contact  for 1 mm plastic fibre		20 10 001 3211	20 10 001 3221	 20 10 001 3211 + 20 10 001 3221																		

Han-Com